

CMS38P03H8-HF

P-Channel
RoHS Device
Halogen Free

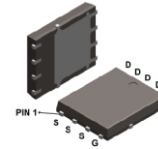

Features

- Super low gate charge.
- 100% EAS guaranteed.
- Excellent C_{dv}/dt effect decline.
- Advanced high cell density technology.

Mechanical data

- Case: PDFN5x6-8L, molded plastic.
- Molding compound: UL flammability classification rating 94V-0.
- Terminals: Matte tin plated leads, solderability per MIL-STD-202, method 208.

Circuit Diagram

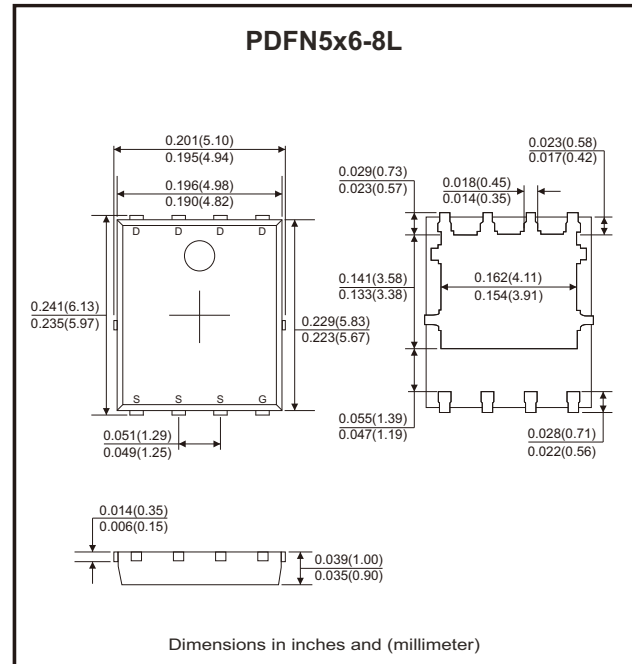
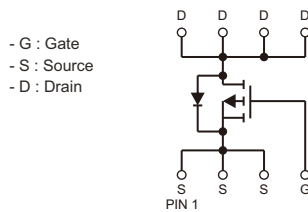

Maximum Ratings (at $T_A=25^\circ\text{C}$ unless otherwise noted)

Parameter	Symbol	Value	Unit
Drain-source voltage	V_{DSS}	-30	V
Gate-source voltage	V_{GSS}	± 20	V
Continuous drain current ($T_C=25^\circ\text{C}$, $V_{GS}=-10\text{V}$)	I_D	-38	A
Continuous drain current ($T_C=100^\circ\text{C}$, $V_{GS}=-10\text{V}$)	I_D	-22	
Pulsed drain current (Note 1)	I_{DM}	-88	A
Avalanche energy, single pulsed (Note 2)	E_{AS}	15	mJ
Power dissipation ($T_C=25^\circ\text{C}$)	P_D	50	W
Thermal resistance junction to air (Note 4)	$R_{\theta JA}$	50	$^\circ\text{C}/\text{W}$
Thermal resistance junction to case (Note 4)	Top	20	$^\circ\text{C}/\text{W}$
	Bottom	2.5	
Operating junction temperature range	T_J	-55 to +150	$^\circ\text{C}$
Storage temperature range	T_{STG}	-55 to +150	$^\circ\text{C}$

Electrical Characteristics (at T_J=25°C unless otherwise noted)

Parameter	Symbol	Conditions	Min	Typ	Max	Unit
Static Characteristics						
Drain-source breakdown voltage	V _{DSS}	V _{GS} = 0V, I _D = -250μA	-30			V
Zero gate voltage drain current	I _{DSS}	V _{DS} = -30V, V _{GS} = 0V, T _J = 25°C			-1	μA
		V _{DS} = -30V, V _{GS} = 0V, T _J = 125°C			-100	
Gate-body leakage current	I _{GSS}	V _{GS} = ±20V, V _{DS} = 0V			±100	nA
On Characteristics						
Static drain-source on-resistance (Note 3)	R _{DS(on)}	V _{GS} = -10V, I _D = -10A		18	20	mΩ
	R _{DS(on)}	V _{GS} = -4.5V, I _D = -6A		27	32	mΩ
Gate threshold voltage	V _{GS(th)}	V _{DS} = V _{GS} , I _D = -250μA	-1	-1.4	-2.5	V
Dynamic Characteristics						
Input capacitance	C _{iss}	V _{GS} = 0V, V _{DS} = -15V, f = 1MHz		1588		pF
Output capacitance	C _{oss}			186		
Reverse transfer capacitance	C _{rss}			152		
Switching Characteristics						
Turn-on delay time	t _{d(on)}	V _{GS} = -10V, V _{DD} = -15V, I _D = -10A R _G = 3Ω		8.2		ns
Turn-on rise time	t _r			18.6		
Turn-off delay time	t _{d(off)}			31.8		
Turn-off fall time	t _f			18.4		
Total gate charge	Q _g	V _{GS} = -10V, V _{DD} = -15V, I _D = -10A		31		nC
Gate to source charge	Q _{gs}			3.2		
Gate to drain (miller) charge	Q _{gd}			6.0		
Source-Drain Diode Characteristics						
Diode forward voltage	V _{SD}	I _{SD} = -10A, V _{GS} = 0V		-0.88	-1.2	V
Source drain current (body diode)	I _{SD}	T _A = 25°C			-36	A

Notes: 1. Repetitive rating; pulse width limited by max. junction temperature.

2. Limited by T_J max, starting T_J=25°C, L=0.5mH, R_G=25Ω, V_{DS}=-10V, V_{GS}=-10V.

3. The data tested by pulsed, pulse width ≤ 300μs, duty cycle ≤ 2%.

4. Device on 40mm x 40mm x 1.5mm epoxy PCB FR4 with 6 cm² (one layer, 70μm thick) copper area for drain connection. PCB is vertical in still air.

Rating and Characteristic Curves (CMS38P03H8-HF)

Fig.1 - On-Region Characteristics

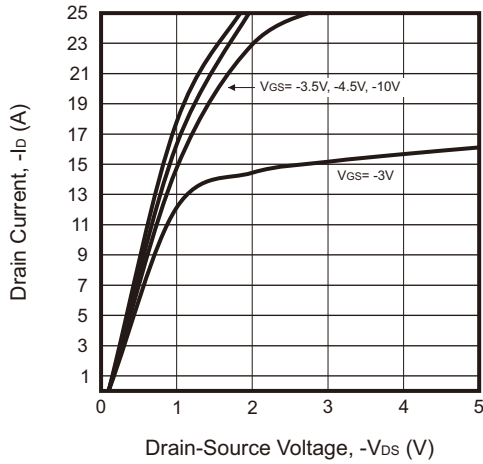

Fig.2 - On-Resistance vs. Drain Current and Gate Voltage

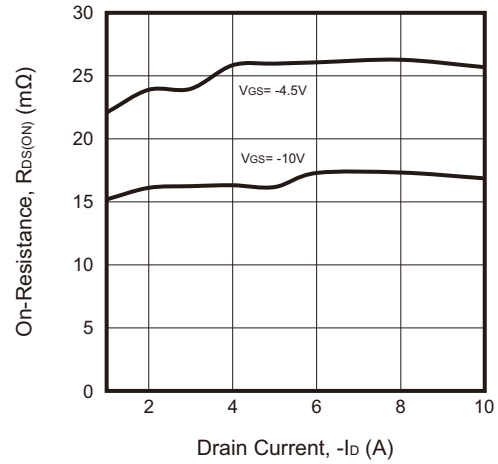

Fig.3 - On-Resistance vs. Gate-Source Voltage

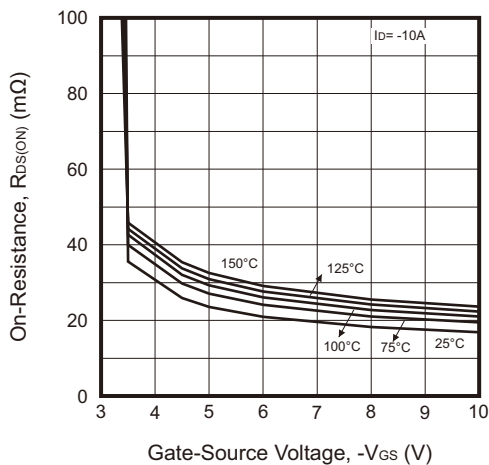

Fig.4 - Body-Diode Characteristics

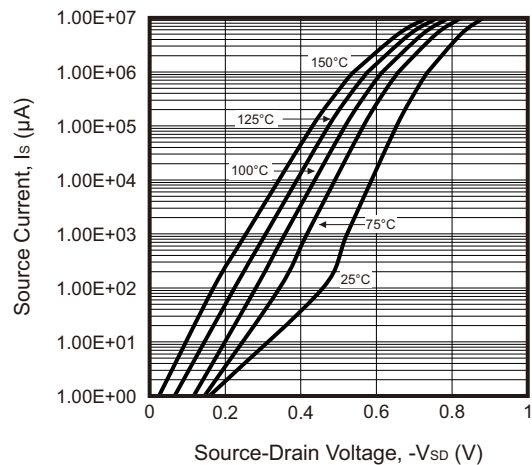

Fig.5 - On-Resistance vs. Junction Temperature

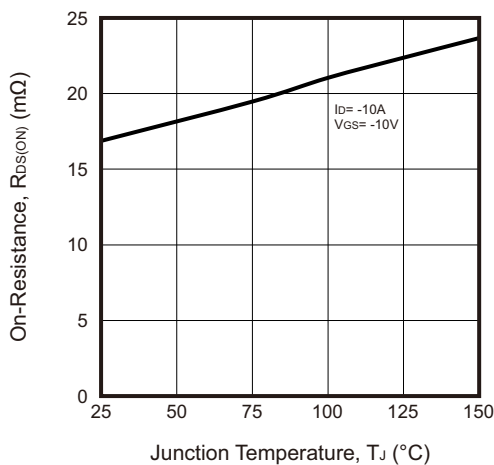
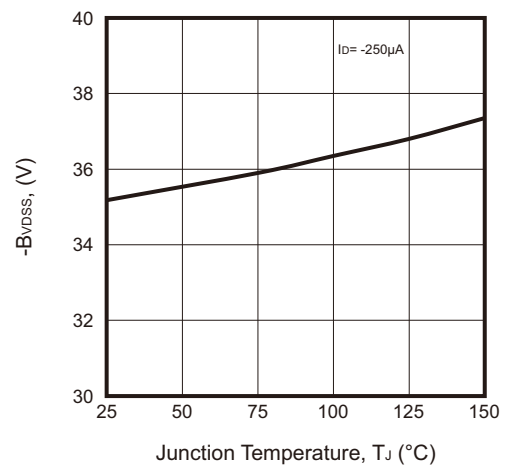

Fig.6 - Drain Source vs. Junction Temperature



Rating and Characteristic Curves (CMS38P03H8-HF)

Fig.7 - Capacitance Characteristics

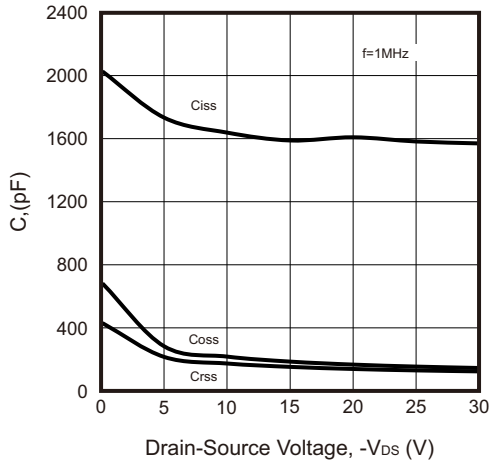

Fig.8 - Gate Voltage vs. Junction Temperature

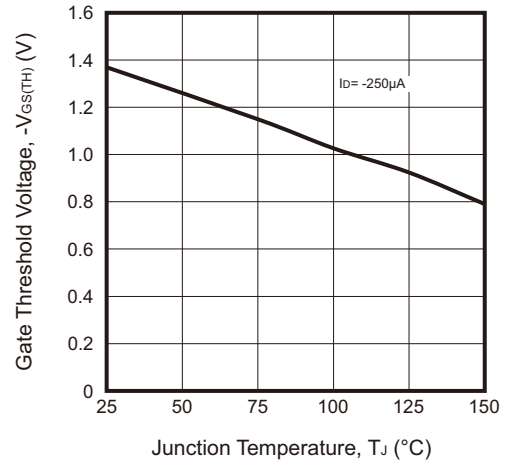

Fig.9 - Transfer Characteristics

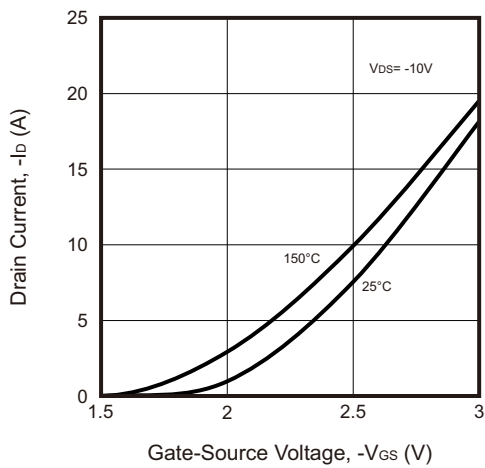
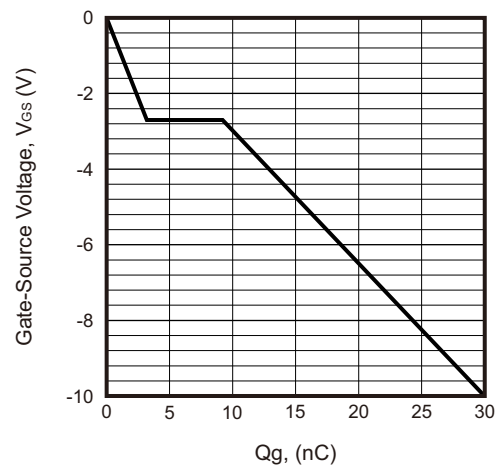
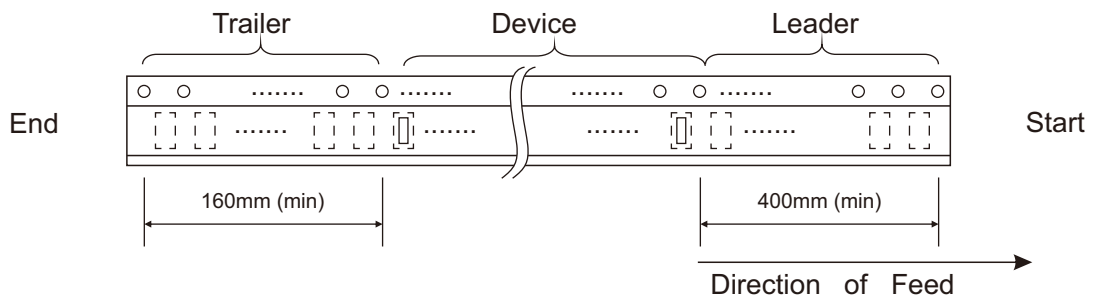
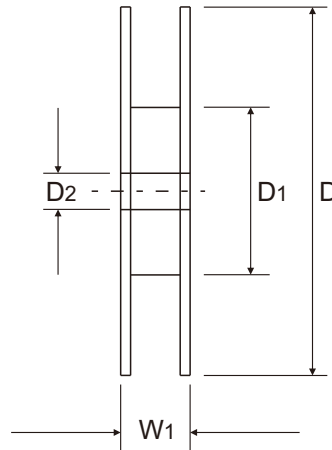
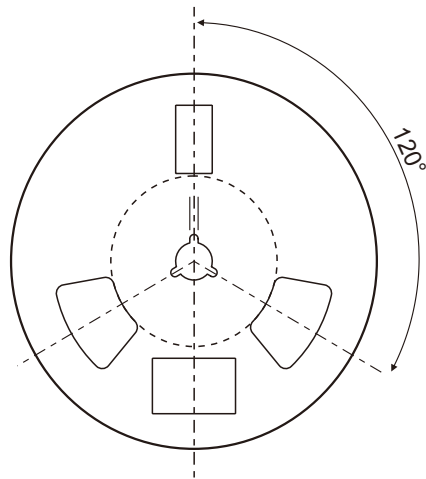
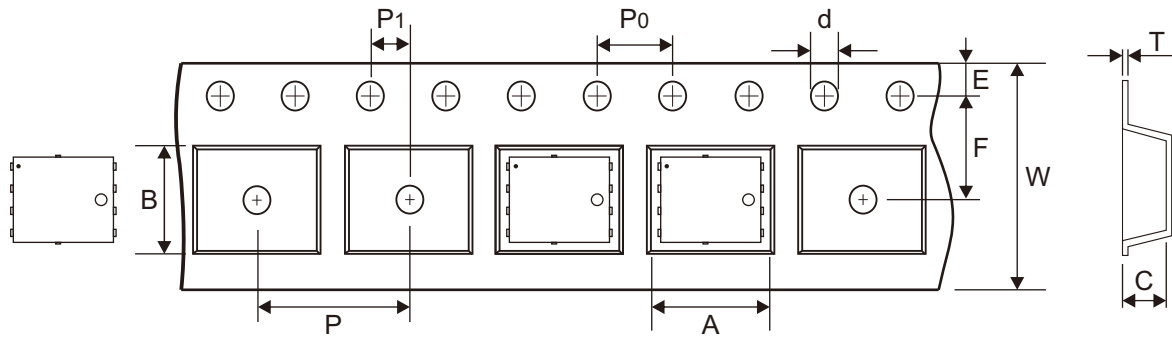

Fig.10 - Gate Charge Characteristics



Reel Taping Specification



PDFN5x6-8L	SYMBOL	A	B	C	d	D	D1	D2
	(mm)	6.30 ± 0.10	5.30 ± 0.10	1.20 ± 0.10	1.55 + 0.01	330 ± 1.00	100 ± 1.00	13.00 ± 0.20
	(inch)	0.248 ± 0.004	0.209 ± 0.004	0.047 ± 0.004	0.061 + 0.0004	12.992 ± 0.039	3.937 ± 0.039	0.512 ± 0.008

PDFN5x6-8L	SYMBOL	E	F	P	P0	P1	T	W	W1
	(mm)	1.75 ± 0.10	5.50 ± 0.10	8.00 ± 0.10	4.00 ± 0.10	2.00 ± 0.05	0.25 ± 0.03	12.00 + 0.30 - 0.10	17.80 ± 0.30
	(inch)	0.069 ± 0.004	0.217 ± 0.004	0.315 ± 0.004	0.157 ± 0.004	0.079 ± 0.002	0.010 ± 0.001	0.472 + 0.012 - 0.004	0.701 ± 0.012

Marking Code

Part Number	Marking Code
CMS38P03H8-HF	200P03T

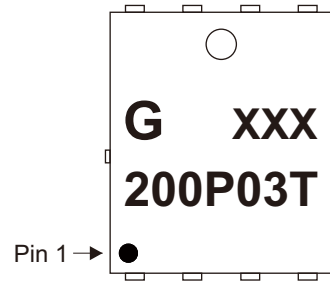

XXX = Control code

Suggested P.C.B. PAD Layout

SIZE	PDFN5x6-8L	
	(mm)	(inch)
A	0.80	0.031
B	1.00	0.039
C	1.27	0.050
D	0.47	0.019
E	0.80	0.031
F	0.85	0.033
G	4.50	0.177
H	4.60	0.181

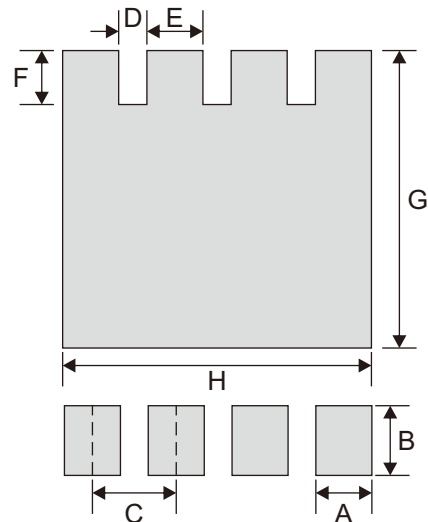

Standard Packaging

Case Type	REEL PACK	
	REEL (pcs)	Reel Size (inch)
PDFN5x6-8L	5,000	13